

DACIA
GOOD THINKING

ALL-NEW DACIA JOGGER



July 2022





THE FAMILY CAR REINVENTED

Featuring the length of an estate, the spaciousness of an MPV and the robust style of an SUV, All-New Dacia Jogger surprises by combining the best of these categories in a 7-seater family car. Versatile, elegant and affordable, All-New Jogger fully embodies the Dacia spirit.



PARK

JOGGER

DESIGNED FOR ADVENTURE

With its raised ground clearance, emphatic wheel arches and modular roof bars, All-New Dacia Jogger has a robust design that adapts to all roads, making it ideal for families with action-packed lives. In keeping with the times, the new model's Y-shaped brand lighting signature confirms its kinship with the new Dacia generation. The LED dipped headlights provide more intense lighting at night. At the rear, the

vertical positioning of the lights broadens the tailgate opening, optimising boot access. Go all out with the Extreme Special Edition, which boasts gloss black alloy wheels and door mirrors, a shark-fin aerial, distinctive decals and Megalith Grey skid plates. The All-New Dacia Jogger, designed for you and your family.



EXTREME SE ALLOY WHEELS



MODULAR ROOF BARS

MUCH MORE THAN FUNCTIONAL

All-New Jogger's interior design is as functional as it is comfortable. The wide dashboard accentuates the impression of space. A textile strip running across the dashboard* provides a clean, uncluttered look that makes it easier to read the instrument panel and the multimedia screen above. The lower area provides easy access to the air conditioning and driver assistance system controls. The rear boasts impressive

versatility. For a 100% elegant and dynamic style, opt for the Extreme Limited Edition with red interior topstitching, white door mouldings, rear view camera, climate control keyless entry. All-New Jogger, all-new prospects! All you have to do is take advantage of it.

*depending on version.





ENJOY ENHANCED TRAVEL

More space and more versatility thanks to a unique approach to spaciousness, with 23,1 litres of useful storage areas for everyday use and multiple configurations to meet all your needs. Three multimedia equipment packages and latest-generation driver assistance systems.







COMFORT MULTIPLIED BY 7

All-New Jogger embraces the whole family . It takes everyone's needs into account, offering the same level of comfort in all rows. The sculpted seats – adjustable at the front – promise fatigue-free travel for all seven occupants. All-New Jogger also stands apart through well thought-out details and spaciousness. In the second row, there are tray tables* with cup holders and practical Isofix attachments for child seats. The third row offers record accessibility, with two individual seats with armrests providing

uncompromising accommodation for two adults with generous legroom. Storage spaces totalling 23,1 litres are distributed throughout the passenger compartment to the benefit of all passengers. All-New Jogger adds a new dimension to your on-board experience.

* featured on Extreme SE.



SLIDING TRAY TABLES AT THE REAR

RECORD MODULARITY

Whatever your plans, the All-New Dacia Jogger offers unique volume and versatility, with removable third row of seats, a 1/3-2/3 split-folding bench seat in the second row, and multiple possible configurations with 2, 3, 4, 5, 6 or 7 seats. It is as versatile as a Swiss army knife! Enjoy boot volume of up to 1,807 litres* and a loading height ready to swallow up anything you

care to take with you. Everything has been designed to meet the needs of your family: even the tray tables** in row 2 slide out to adapt to your body shape. You can trust All-New Dacia Jogger to simplify your adventures, be it in the city or further afield.

* maximum boot volume in dm³ in accordance with the VDA standard (2094L), with rear bench folded down and third row removed.

** depending on version.







DACIA

ESP
ABS

12 km
12.1 km

90 110 130 150 170
km/h

25°C 10:15 AM

Radio Media Phone

Vehicle Nav Smartphone integration

Set time Settings

PASSENGER AIR BAG

ECO

21.0

A/C

CHOOSE YOUR CONNECTIVITY

Connect according to your needs and priorities. All-New Dacia Jogger is available with three comprehensive multimedia offerings – the choice is yours. Benefit from the ingenious smartphone-controlled Media Control built into the dashboard design, Media Display featuring an 8-inch touchscreen, and Media Nav with navigation. Radio, music, Bluetooth, USB, telephone, navigation, voice recognition. The system of your choice provides the essentials and more, right up to AndroidAuto™

and Apple CarPlay™ compatibility. Smartphone replication via USB cable is also available. You also get to enjoy 3D sound (Arkamys™ System) thanks to the 6 speakers distributed throughout the passenger compartment, depending on the version.

Android Auto™ is a Google Inc. brand. Apple CarPlay™ is an Apple Inc. brand.



MEDIA CONTROL



MEDIA DISPLAY

DRIVE IN COMPLETE SAFETY

At Dacia, safety has always been at the heart of our concerns. Built on the latest platform designed for our vehicles, All-New Dacia Jogger has a reinforced body structure and new-generation assistance systems that make driving easier. Drive with complete peace of mind.

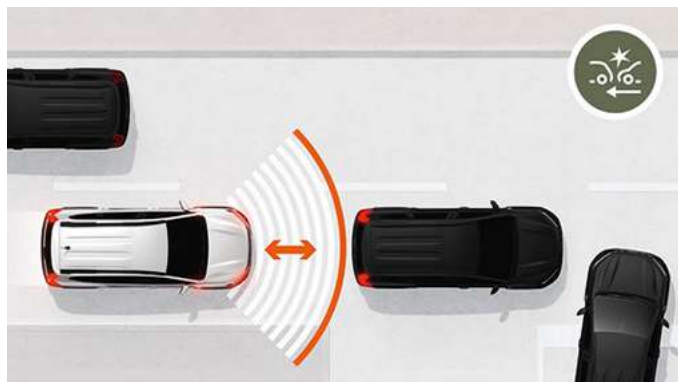

AUTOMATIC EMERGENCY BRAKING

The system is active between 7 and 170 km/h and equipped with a front sensor that monitors the distance between your vehicle and the vehicle in front of you. If the vehicle in front slows down or stops, you are notified by a dual audio and visual warning. If your response is slow or insufficient, braking assistance is automatically applied.

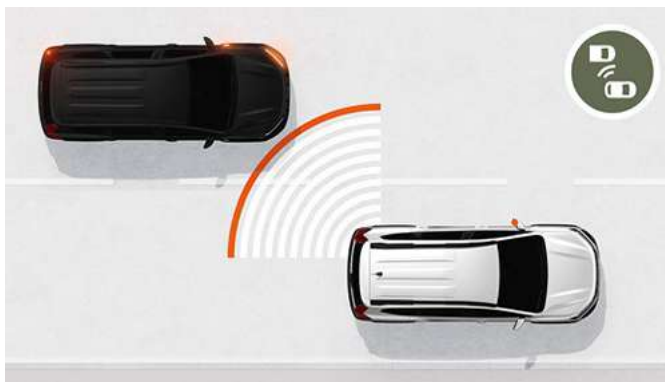

BLIND SPOT WARNING

Active from 30 km/h, this system automatically alerts you, via warning lights in the door mirrors, of the presence of vehicles in your blind spot.



AIRBAGS

Dacia's new-generation airbags are equipped with door pressure sensors and an accelerometer providing early detection of side collisions. The curtain and side airbags deploy more quickly for optimum protection of the abdomen, chest and head.



Blind spot warning



Cruise control

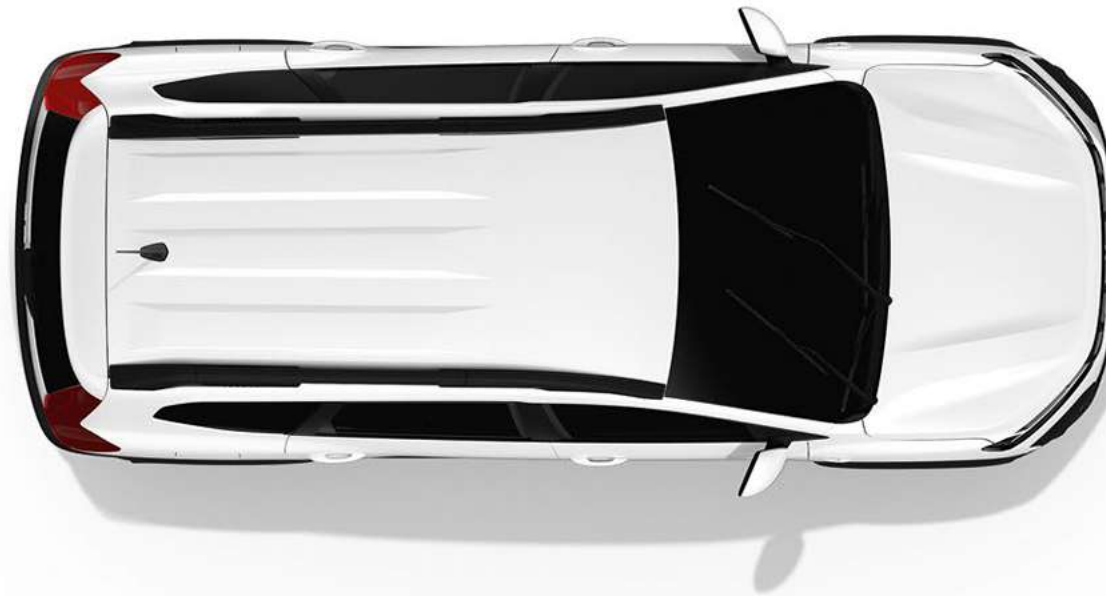

Rear and front parking sensors



Automatic emergency braking



Hill start assist



Speed limiter

DACIA JOGGER AMBIANCES

ESSENTIAL



MAIN EQUIPMENT ESSENTIAL

EXTERIOR APPEARANCE

- New grille with new logo and white trim
- LED light signature (DRL) & LED Automatic front low beam
- Black door handles
- Black door mirrors
- Longitudinal roof bars
- Body colour front and rear bumpers
- 16" steel wheels with full wheel trims
- High ground clearance 200 mm
- Black front and rear skid plates
- 25% tinted windows

INTERIOR APPEARANCE

- Fog Grey vent towers and white sliders
- Black door handles
- Parcel shelf (only for 5 seats)
- Essential Upholstery

DRIVING AND CONTROLS

- Electric power steering
- Hill start assist
- Stop & Start, Eco mode
- Speed limiter

ACTIVE AND PASSIVE SAFETY

- ABS (Anti-lock Braking System) and EBA (Emergency Brake Assist)
- Intercity Automatic Emergency Braking (AEBs)
- ESP (Electronic Stability Program) + HSA (Hill Start Assist)
- Emergency Call (E-call)
- ESC (Emergency stability control)
- 6 Airbags (front and side Driver & passengers including curtain airbags)
- Front and passenger airbag deactivation
- Front and rear seat belts with pretensioner and force limiter
- Tyre pressure Monitor
- Tyre inflation kit
- ISOFIX fix points for child seats.
- Engine immobilizer

COMFORT

- Manual heating system with air conditioning
- Automatic door locking
- Remote door locking
- Front power windows
- Front USB port & 12V Plug
- Height adjustable steering wheel and height adjustable driver seat
- Folding rear bench 1/3 & 2/3 (seat & back)

AUDIO

- Media Control: DAB Radio with switches on the steering wheel, display integrated into the trip computer, smartphone support integrated in the dashboard, 2 front speakers, Bluetooth connection + Smartphone application Dacia Media Control

OPTIONS

- Metallic paint
- Emergency spare wheel

DACIA JOGGER AMBIANCES

EXPRESSION



MAIN EQUIPMENT EXPRESSION = ESSENTIAL +

EXTERIOR APPEARANCE

- Body colour door handles
- Modular roof bars
- 16" steel Flex wheel
- 75% rear tinted windows
- Megalith Grey front and rear skid plates

INTERIOR APPEARANCE

- Fog Grey air vents
- Driver's seat armrest
- Steel Grey interior door handles
- Fog Grey interior trim
- Specific Expression upholstery
- Fabric deco parts on the dashboard and front door-armrests

DRIVING AND CONTROLS

- Cruise control
- Blind Spot Warning
- Rear parking sensors and rear parking camera

VISIBILITY

- Automatic wipers
- Door mirrors - heated and electrically-adjustable

COMFORT

- Soft-feel height & depth adjustable steering wheel
- 12V Plug front & rear
- Height adjustable driver's seat
- Manual AC
- Keyless entry card

AUDIO

- Media Display: Android Auto™ and Apple CarPlay™ compatibility with smartphone replication via USB cable (DAB radio with 8" touch screen and 4 speakers)

OPTIONS

- Metallic paint
- Emergency spare wheel

Android Auto™ is a Google Inc. brand. Apple CarPlay™ is an Apple Inc. brand.

DACIA JOGGER AMBIANCES

EXTREME



MAIN EQUIPMENT EXTREME = EXPRESSION +

EXTERIOR APPEARANCE

- "Extreme" specific outdoor design with lateral stickers
- 16" Black alloy wheels with Extreme decals
- Gloss Black door mirrors
- Gloss Black shark antenna

INTERIOR APPEARANCE

- "Extreme" specific upholstery with red stitching
- Front and rear floor mats and boot tray
- Steel Grey door opener
- White decoration strips on door panels
- Flight trays for 2nd row passengers

COMFORT

- Automatic air conditioning
- Key less entry card

AUDIO

- MediaNav⁽¹⁾ navigation, DAB radio, smartphone mirroring via USB, Bluetooth connection, six speakers (4 speakers + 2 tweeters), 8" touch screen

OPTIONS

- Metallic paint
- Emergency spare wheel

(1) Compatible with Apple CarPlay™ & Android Auto™. Android Auto™ is a trademark of Google Inc. Apple CarPlay™ is a trademark of Apple Inc.

DACIA JOGGER
COLOUR



TERRACOTTA BRONZE⁽¹⁾



MOONSTONE GREY⁽¹⁾



GLACIER WHITE⁽²⁾



SLATE GREY⁽¹⁾



PEARL BLACK⁽¹⁾



DUSTY GREY⁽²⁾



URBAN GREY⁽²⁾

(1) Metallic paint. (2) Opaque paint.

DIMENSIONS

FRONT VIEW

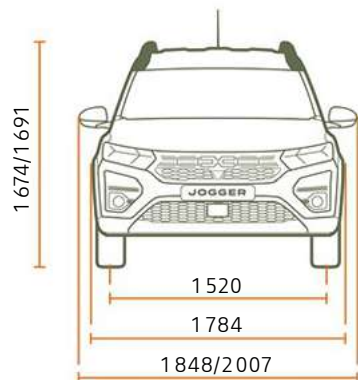

7-SEATER SIDE VIEW

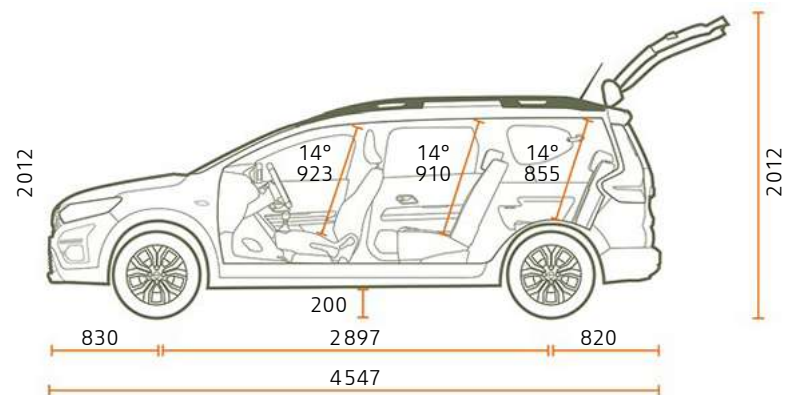

BACK VIEW



TOP VIEW 7-SEATER

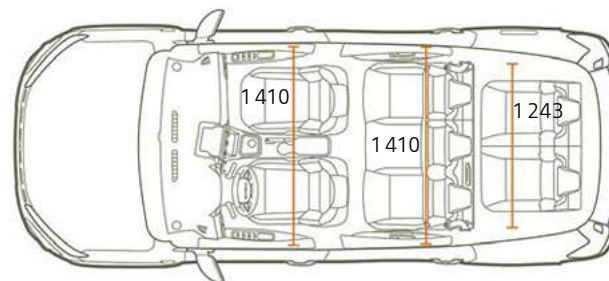

BOOT VOLUME - (in dm³ - VDA standard / litres)

7 SEATS

Minimum boot volume – (ISO 3832 standard)

160/212

Maximum boot volume – (ISO 3832 standard)

1807/2085

Row 2 in place and row 3 folded down

565/699

Row 2 in place and row 3 removed

696/820

Dimensions in mm.

DACIA JOGGER ACCESSORIES



1.

1. COACH BICYCLE RACK - ON TOW BAR - 3 BIKES - 13 PINS

Make everything easier with this bike rack that can carry up to three bikes. Quick to attach to the tow bar and without the need for any adjustments, it is the ideal solution for frequent use.

2. ROOF SPOILER

Accentuate the sporty character of your vehicle.

3. SIDE STEPS

Getting in and out of the vehicle or accessing cargo on the roof has never been easier.

An accessory that's also essential to enhance the robust style of your new Jogger.



2.



3.

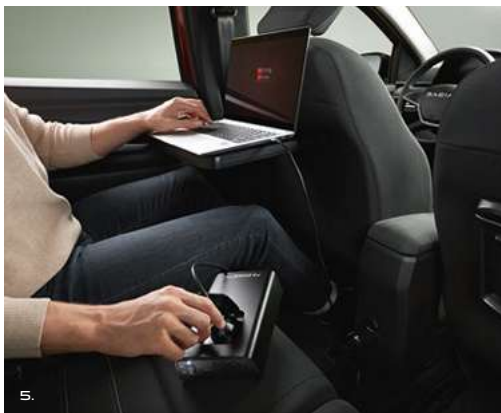

4. SMARTPHONE INDUCTION CHARGER

Ingenious accessory that makes your daily life easier with convenient, effortless and fast induction charging. There are two possible attachments: on the air vent or on the arm.

5. 12-220V CONVERTER

Charge all your everyday electrical devices using this converter: computer, drone, scooter or electric bike.

6. EASYFLEX MODULAR BOOT PROTECTION

Cover your entire boot to transport bulky and dirty items. The non-slip protection folds and unfolds by adapting to the position of the seats, versatile and practical for your daily life and leisure activities.

7. ARMREST WITH STORAGE SPACE AND CUP HOLDER ORGANISER

Enjoy driving comfort and additional storage with this height-adjustable armrest, compatible with a mid-height console. With the cup-holder organiser, you can store your keys, coins, cans or bottles at your fingertips.

8. RUBBER FLOOR MATS

Protect the floor of your car interior using rubber mats with raised edges specially designed for your new Jogger. Waterproof and easy to maintain, they can be attached quickly using the safety clips provided for this purpose. An effective solution against dirt, mud and dust.

9. FRONT DOOR SILLS AND PREMIUM TEXTILE FLOOR MATS

Customise and protect the areas around your vehicle's doors with style. The JOGGER lacquered black finish adds a touch of exclusivity. Add additional protection to your vehicle with textile floor mats. High-quality, practical and easy-to-clean.

EQUIPMENT & OPTIONS

	ESSENTIAL	EXPRESSION	EXTREME SE
EXTERIOR APPEARANCE			
LED light signature (DRL) & LED front low beam	•/•	•/•	•/•
New brand identity front grille with white detailing	•	•	•
Front and rear bumpers	Body coloured	Body coloured	Body coloured
Skid plates - front and rear	Black	Megalith Grey	Megalith Grey
Lower door protection sticker/ Additional «snorkel» type	-/-	Black/-	Specific Extreme design/•
Outside door handles	Black	Body coloured	Body coloured
Door mirrors	Black	Body coloured	Glossy black
Longitudinal roof bars	•	-	-
Modular longitudinal roof bars	-	•	•
Shark antenna Shiny Black	-	-	•
16" Steel wheels	With hubcap	Flexwheel	-
16" Diamond-cut alloy wheels - gloss black	-	-	•
INTERIOR APPEARANCE			
Airvents surrounds	Fog Grey	Fog Grey	Fog Grey
Door handles	Black	Steel Grey	Steel Grey
Fabric deco parts on the dashboard and front door-armrests/ White deco part on front doors panels	-/-	•/-	•/•
Folding rear bench 1/3 & 2/3	•	•	•
2 Independent Foldable & removable 3 rd row seats	•	•	•
Soft feel steering wheel	-	•	•
Floor mats with «Jogger» inscription & Boot protection	-	-	•
Luggage space cover	-	•	•
ACTIVE & PASSIVE SAFETY			
ABS (Anti-block Braking System) and AFU	•	•	•
Advanced Emergency Brake Assist System (AEBS) Interurbain	•	•	•
ESP (Electronic Stability Program) + HSA (Hill Start Assist)	•	•	•
Emergency call (E-call)	•	•	•
Driver's airbag/Front Passenger's airbag with deactivation	•/•	•/•	•/•
Side airbags (thorax & curtains (front + rearm)	•	•	•
Rear seatbelts pyrotechnic with force limiter for side seats	•	•	•
Hill start assist	•	•	•
Rear parking sensors	•	•	•
Rear view camera	-	•	•
Front parking & rear parking sensors + Rear Camera + Blind Spot Warning	-	•	•
Keyless entry card + electric parking brake with central high armrest and storage inside	-	•	•
Electric Parking brake	-	•	•
Tyre Pressure monitor	•	•	•
Inflating kit	•	•	•
Emergency spare wheel	○	○	○
Isofix fixation system for child seats on both rear side seats 2nd row	•	•	•

	ESSENTIAL	EXPRESSION	EXTREME SE
DRIVING AND CONTROLS			
Electric power steering	•	•	•
Stop & Start , ECO Mode	•	•	•
Trip computer: distance, average speed,fuel range, average fuel consumption	•	•	•
Speed limiter with audible warning/ Cruise Control	•	•	•
VISIBILITY			
Front fog lights	•	•	•
Electric adjustable door mirrors	-	•	•
Manually adjustable door mirrors	•	-	-
COMFORT			
Manual air conditioning	•	-	-
Automatic air conditioning	-	•	•
Automatic wiping	-	•	•
Remote door locking and automatic door locking	•	•	•
Keyless entry card	-	•	•
Front power windows	•	-	-
One touch power window for driver side & normal front passenger power window	-	•	•
Electric rear windows	-	•	•
Height & depth adjustable steering wheel + Cruise Control	•	•	•
USB port	•	•	•
12V Socket front/rear	•/-	•/•	•/•
Heated front seats	-	-	•
Rear parcel shelves	-	•	•
Tilting rear quarter glass	-	-	•
High central armrest with console storage	-	-	•
AUDIO			
Media Control : DAB Radio with switches on the steering wheel, display integrated in the trip computer, smartphone support integrated in the dashboard, 2 front speakers, Bluetooth connection + Smartphone application Dacia Media Control	•	-	-
Media Display 8": DAB Radio + Smartphone replication via USB cable + Bluetooth connection + 4 speakers + 8" Display	-	•	-
Media Nav ⁽¹⁾ : MAP CARE navigation (Western or Eastern Europe maps + 6 free updates for 3 years), DAB radio, smartphone replication via USB cable, Bluetooth® connection, 6 speakers (4 speakers + 2 tweeters), 8" touch screen, 1 additional USB at the bottom of the central consolep	-	-	•

- : not available; • : available as standard; ○ : available as an option/pack. (1) compatible with Apple CarPlay™ and Android Auto™. Android Auto™ is a Google Inc. brand. Apple CarPlay™ is an Apple Inc. brand.

DACIA JOGGER PRICING

		CO ₂ G/KM WLTP	FUEL TYPE	COMBINED FUEL CONSUMPTION (MPG) - WLTP	BHP	BENEFIT IN KIND	VED YEAR 1	BASIC PRICE	VAT 20%	TOTAL RETAIL PRICE	ON THE ROAD PRICE*
DACIA JOGGER											
Essential	TcE110 MY23	130	Petrol	48.7	110	29%	190	£13,170.83	£2,634.17	£15,805.00	£16,645
Expression	TcE110 MY23	131	Petrol	48.7	110	29%	230	£14,220.83	£2,844.17	£17,065.00	£17,945
Extreme SE	TcE110 MY23	130	Petrol	47.8	110	29%	190	£14,920.83	£2,984.17	£17,905.00	£18,745

* "On the Road" price includes delivery to the dealer premises, number plates, 12 months government road fund license (depending on CO₂ emissions) and First Registration Fee at £55.

OPTIONS

	ESSENTIAL	EXPRESSION	EXTREME SE	BASIC PRICE	VAT 20%	TOTAL RETAIL PRICE
OPTION						
Metallic paint	○	○	○	£495.83	£99.17	£595
Spare Wheel	○	○	○	£250.00	£50.00	£300

DACIA JOGGER ENGINE

TCe 110

ENGINES

Fuel	Petrol
Max. power kW CEE (hp) at an engine speed of (rpm)	81 kW/5,000-5,250 rpm
Max. torque Nm CEE (m.kg) at an engine speed of (rpm)	200 Nm/2,900-3,500 rpm
Gearbox type	Manual
Type of injection	turbo direct injection
Capacity (cm ³)	999
Number of cylinders/valves	4/4
Emission control standard	Euro6 D-final

CHASSIS AND STEERING

Tyre dimensions	205/60 R16 92H
Steering - Turning circle, kerb to kerb (m)	11.7
Front suspension	Pseudo McPherson with lower wishbone, spiral spring suspension with telescopic hydraulic shock absorbers and anti-roll bar
Rear suspension	Semi-rigid axle with anti-roll bar spring suspension and telescopic hydraulic shock absorbers

PERFORMANCE

Maximum speed (km/h)	183 km/h
0-100 km/h (s)	32.5 s
Mid-range acceleration: 80 km/h - 120 km/h (s) in 4 th	8.9 s
5 th	12.3 s
6 th	19.7 s

FUEL CONSUMPTION AND EMISSIONS⁽¹⁾

Approval protocol	WLTP ⁽²⁾
Fuel tank capacity (l)	50
CO ₂ emissions (g/km)	130 (131 for Expression version)
Consumption over a combined cycle (mpg)	48.7 (47.8 for Extreme SE)

VOLUMES AND WEIGHTS

Minimum kerb weight	1,205
Maximum kerb weight	1,261
Gross train weight (GTW)	3,062
Maximum permissible laden weight (MPLW)	1,862
Max. braked towing weight	1,200

(1) Official consumption and emissions according to applicable regulations. (2) WLTP (Worldwide Harmonized Light Vehicle Test Procedures): this new protocol provides results much closer to those found in daily use compared to the NEDC protocol. CO₂ emissions are certified using a standard, regulated method. This method is identical for all manufacturers and enables vehicles to be compared.

DRIVE, TRAVEL, ENJOY... NOW THAT'S THE DACIA SPIRIT!

At Dacia, we offer practical, reliable vehicles that offer the best value for money. Models with assertive style but no frills, fitted with the most reliable, tried-and-tested technologies... all at an unbeatable price. In fifteen years, we have changed the rules of the game and disrupted the car market. Unbelievable? Not really. Our secret? A perfect blend of simplicity, transparency and accessibility. From the choice of model to price and maintenance, everything is clear and obvious with Dacia.

Driving Dacia means being sure you've made the right choice. It means choosing quality, reliability, design, comfort and, above all, a fair price. It means being able to buy a new vehicle that meets your needs. Finally, driving a Dacia means no longer putting all of your money into your vehicle – you can still go on holidays, give your daughter the guitar of her dreams, or simply save up.



**BIGGER, COOLER,
JOGGER**





DACIA JOGGER

WE'VE GOT YOU COVERED

You might think our shockingly affordable prices mean our cars aren't made to last. Actually, the Dacia range is one tough cookie. To prove it, you get a 3-year* warranty (or 60,000 miles, if you reach that first). This means we will replace any part which has been deemed by a Dacia approved dealer to be defective due to a manufacturing fault, free of charge. To keep the good times rolling, you can extend your warranty up to 7 years for a great price. We also give you a 2-year paintwork and 6-year anti-corrosion warranty, so you can kick back knowing that your Dacia will stay looking good-as-new for years to come.

ROADSIDE ASSISTANCE

Although our cars are built for plain sailing, you can rely on us if you have a breakdown – 24/7 365, wherever you are in the UK or Northern Ireland. This offer also stands for the first 3 years/60,000 miles Δ after you buy your new Dacia.

DACIA CAR INSURANCE 1

Dacia Insurance has been specifically created to provide superb protection for you and your car. Unlike most other UK insurers, in the event of an accident, your Dacia will be repaired at a Dacia Approved Bodyshop using only Dacia approved parts and approved repair methods. This maintains your Dacia's safety rating, protects its resale value and helps to maintain its Dacia warranty Δ . Dacia Insurance also offers a courtesy car for the duration of a repair at a Dacia Approved Bodyshop.

Dacia car insurance: 0330 102 7795 www.daciacarinsurance.co.uk

Lines are open Mon - Thurs 8.30am - 7pm, Fri 9am - 6pm, Sat 9am - 5pm

SERVICING

Dacia Service Plans are the ultimate hassle free way to take care of your vehicle. Depending on the Service plan you purchase (see opposite grid) your servicing needs are covered and you benefit from;

- Inflation Proof Servicing – You know exactly what you'll pay and there are no hidden costs
- Peace of Mind – No matter where life takes you, we'll be there in over 5000 workshops across Europe
- Dacia Expertise & Quality – Our highly trained technicians know your Dacia inside out

The Dacia Service Plan contains Dacia services in-line with the manufacturer's service schedule, plus comes with a complimentary vehicle health check to ensure your Dacia is in the best condition possible.

	Cash Price	Monthly payments with Dacia Finance**		Total Retail Price
Service plan[^]			Extended warranty	
3 years / 30,000 miles Service Plan	£486	£9.99 per month	4 years / 60,000 miles [†]	£150
4 years / 40,000 miles Service Plan	£816	£11.99 per month	5 years / 60,000 miles [†]	£275
			6 years / 60,000 miles [†]	£400
			4 years / 100,000 miles [†]	£400
Servicing[^] + Extended Warranty Plan			5 years / 100,000 miles [†]	£525
4 years / 60,000 miles	£1,152	£17.99 per month	6 years / 100,000 miles [†]	£650

Service Intervals^o

Annual servicing **OR** servicing at 18,000 miles (whichever comes first)

Service Schedule ^o	Year 1	Year 2	Year 3	Year 4	Year 5	Year 6
	Cabin filter change	Oil change + Cabin filter change	Cabin filter change + Brake fluid change	Oil change + Cabin filter change + Brake fluid change	Cabin filter change + Coolant 150km change	Cabin filter change + Belts 150km change

*Dacia warranty ends when you reach the age or mileage limit (whichever comes first). Subject to status, terms and conditions apply. For full Dacia Extended Warranty Terms and Conditions visit www.dacia.co.uk/warranty-and-assistance/warranty

[^]Roadside assistance for the first 3 year / 60,000 miles, which ever is reached first. For full Terms and Conditions visit www.dacia.co.uk/warranty-and-assistance/assistance

[†] Dacia Extended warranties are available to purchase from first date of registration up to end of manufacturer warranty. For full Dacia Extended Warranty Terms and Conditions visit www.dacia.co.uk/warranty-and-assistance/warranty

The monthly service plan offer is available at point of signing agreement for vehicle purchased under HP and PCP finance agreement provided by Dacia Finance Ltd. (Not available on cash purchases).

^o The Service plan offer is available for eligible retail vehicles only and valid at participating dealers only. Vehicles must be ordered between 01 July 2022 to 30 September 2022 and registered to 31 December 2022. The Dacia Service plan covers the manufacturer's minimum maintenance programme requirements for the term of the Service plan purchased (refer to the Warranty and Service sheet in the Handover Document wallet for details). The plan ends when you reach the age or mileage limit (whichever comes first). Services must be carried out in line with the manufacturer's minimum maintenance programme requirements and servicing intervals within +/- 1 month or 1,000 miles of the service interval and can only be carried out at a Dacia Approved outlet. Service plans do not cover wear and tear items such as (but not limited to) tyres, wiper blades or brakes. For Service plan full Terms & Conditions visit www.dacia.co.uk/services-and-finance/service-plan. Cannot be part exchanged, refunded or transferred.

^o The service schedule and intervals are subject to the registration number. Ask your local dealer to confirm your service schedule / intervals as the above is a guideline.

**36 or 48 monthly payments options are only available at point of signing a finance agreement provided by Dacia Finance, Rivers Office Park, Denham Way, Rickmansworth, WD3 9YS. Guarantees and indemnities may be required. You must be a UK resident (excluding the Channel Islands) and over 18 to apply for finance. Terms and conditions apply.

[^] Dacia Insurance is arranged and administered by Verex Insurance Services Ltd, which is registered in England and Wales No. 05686831 at Batchworth House, Church Street, Rickmansworth, Herts, WD3 1JE and authorised and regulated by the Financial Conduct Authority, No. 487185. Verex Insurance Services Ltd arranges policies from a panel of insurers, details are available on request.

[^]If your insurer uses non-approved parts which subsequently fail, they may not be covered under your manufacturer's warranty.

Every precaution has been taken to ensure this publication is accurate and up to date when printed. This document has been created using pre-production and prototype models. In line with its policy of continuous product improvement, Dacia reserves the right to modify the specifications, vehicles and accessories described and featured at any time. Any such modifications are communicated to Dacia dealers as quickly as possible. Depending on the country of sale, versions may differ and certain equipment may be unavailable (as standard, optional or as an accessory). Please consult your Dacia brand representative for the latest information. For technical printing reasons, the colours featured in this document may differ slightly from those of the actual paintwork or interior trim. All rights reserved. Reproduction in any format and by any means of all or part of this publication is prohibited without prior written authorisation from Dacia.

Dacia recommends 

PUBLICIS - PHOTO CREDITS : Ben and Martin, P. JOHALL, A. BERNIER, TWIN GROUP, © RENAULT MARKETING 3D-COMMERCE, PAGECRAN - JULY 2022